

K

Pompes centrifuges monocellulaires horizontales

Petits débits (< à 10 m³/h)



1 ● CARACTÉRISTIQUES GÉNÉRALES

- Pompes centrifuges monocellulaires horizontales de concept monobloc (arbre commun pompe moteur). Adaptées à la surpression domestique, au transport de l'eau, au transvasement, au remplissage de citernes, à l'irrigation et à divers usages domestiques, agricoles et industriels.

Pompe

- Corps de pompe et support moteur en fonte traitée anti-corrosion y compris sur les surfaces internes.
- Roue en technopolymère A.
- Arbre en acier inoxydable (côté pompe).
- Garniture mécanique en Carbone/Céramique.

Moteur

- De type asynchrone, fermé, à refroidissement par ventilateur extérieur.
- Rotor monté sur roulements à billes graissés à vie et sélectionnés pour garantir durée et silence.

- Couvercle ventilateur en tôle galvanisée et peinte.
- Protection thermo-ampèremétrique et condensateur permanent incorporé dans la version monophasée.
- Protection à charge de l'utilisateur pour la version triphasée, selon normes en vigueur.
- Construction selon normes CEI 2-3.
- Indice de protection : IP 44 (boîte à borne IP 55).
- Classe d'isolement : F.
- Voltage de série : monophasé 220-240 V / 50 Hz, triphasé 230-400 V / 50 Hz.
- Moteur triphasé IE 2 à partir de 0,75 kW.

N°	COMPOSANT	MATERIAU	TYPE
1	Corps de pompe	Fonte G 200 UNI ISO 185	
3	Bride moteur	Fonte G 200 UNI ISO 185	
4	Roue	Technopolymère A	
7	Arbre rotor	Acier inox AISI 416 X12 CrS 13 UNI 6900-71	K 20/41-K 30/70-K 12/200
		Acier inox AISI 303 X10 CrNiS 1809 UNI 6900-71	K 30/100 - K 36/100
16	Garniture mécanique	Carbone / Céramique	
28	Joint de corps OR	Caoutchouc NBR	

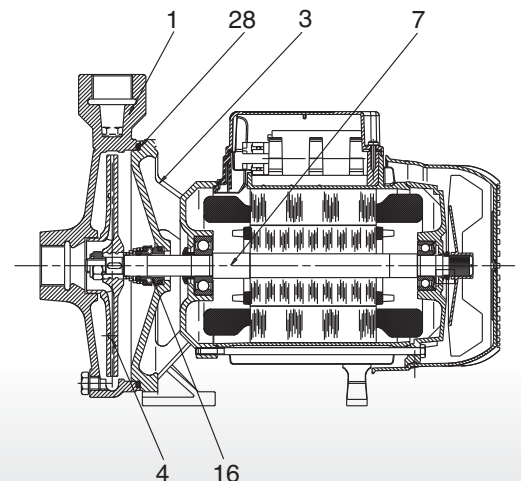

2 ● CARACTÉRISTIQUES TECHNIQUES

- Plage d'utilisation : de 1,6 à 12 m³/h avec hauteur manométrique jusqu'à 35 mètres de C.E.
- Liquide pompé : propre, sans corps solides ou abrasifs, non agressif, non visqueux, non cristallisé et chimiquement neutre, proche des caractéristiques de l'eau.
- Plage de température du liquide : de - 10 °C à + 50 °C.
- Température ambiante maximum : + 40 °C.
- Pression maximum de service : 6 bars (600 kPa).
- Installation : fixe, horizontale ou verticale à condition que le moteur soit positionné sur le dessus de la pompe.

Type	Code	Caractéristiques électriques							Caractéristiques hydrauliques (v = 2800 tr/min)																																																																																					
		Alimentation 50 Hz	P 1		P 2		Ampères A	Condensateur µF	Vc	Q																																																																																				
			Maxi kW	Nominale kW	HP	m ³ /h				0	2,4	3,6	4,8	6	7,2	8,4	9,6	10,8	12	14,4																																																																										
K 20/41 M	033200	1 x 220-240 V ~	0,65	0,37	0,5	3	10	450	<table border="1"> <thead> <tr> <th>H (m)</th> <th>0</th> <th>2,4</th> <th>3,6</th> <th>4,8</th> <th>6</th> <th>7,2</th> <th>8,4</th> <th>9,6</th> <th>10,8</th> <th>12</th> <th>14,4</th> </tr> </thead> <tbody> <tr> <td>22</td> <td>19,4</td> <td>17</td> <td>13,5</td> <td>8</td> <td></td> <td></td> <td></td> <td></td> <td></td> <td></td> <td></td> </tr> <tr> <td>31,8</td> <td>28,9</td> <td>27</td> <td>24,2</td> <td>19,8</td> <td>13,5</td> <td></td> <td></td> <td></td> <td></td> <td></td> <td></td> </tr> <tr> <td>29,2</td> <td>29</td> <td>28,8</td> <td>28</td> <td>26,8</td> <td>25,3</td> <td>23,5</td> <td>21,5</td> <td>18,5</td> <td></td> <td></td> <td></td> </tr> <tr> <td>34,9</td> <td>34,8</td> <td>34,6</td> <td>34</td> <td>33</td> <td>32</td> <td>30,8</td> <td>29</td> <td>26,5</td> <td></td> <td></td> <td></td> </tr> <tr> <td>18,4</td> <td>17,2</td> <td>16,5</td> <td>16</td> <td>15,3</td> <td>14,7</td> <td>13,9</td> <td>13,1</td> <td>12,3</td> <td>11,4</td> <td>9,5</td> <td></td> </tr> </tbody> </table>														H (m)	0	2,4	3,6	4,8	6	7,2	8,4	9,6	10,8	12	14,4	22	19,4	17	13,5	8								31,8	28,9	27	24,2	19,8	13,5							29,2	29	28,8	28	26,8	25,3	23,5	21,5	18,5				34,9	34,8	34,6	34	33	32	30,8	29	26,5				18,4	17,2	16,5	16	15,3	14,7	13,9	13,1	12,3	11,4	9,5	
H (m)	0	2,4	3,6	4,8	6	7,2	8,4	9,6															10,8	12	14,4																																																																					
22	19,4	17	13,5	8																																																																																										
31,8	28,9	27	24,2	19,8	13,5																																																																																									
29,2	29	28,8	28	26,8	25,3	23,5	21,5	18,5																																																																																						
34,9	34,8	34,6	34	33	32	30,8	29	26,5																																																																																						
18,4	17,2	16,5	16	15,3	14,7	13,9	13,1	12,3															11,4	9,5																																																																						
K 20/41 T	033205	3 x 230-400 V ~	0,64	0,37	0,5	2,3 - 1,3	-	-																																																																																						
K 30/70 M	033210	1 x 220-240 V ~	1,3	0,75	1	6	20	450																																																																																						
K 30/70 T	033215	3 x 230-400 V ~	1,2	0,75	1	4,3 - 2,5	-	-																																																																																						
K 30/100 M	033220	1 x 220-240 V ~	1,6	1,1	1,5	8	31,5	450																																																																																						
K 30/100 T	033225	3 x 230-400 V ~	1,63	1,1	1,5	5,5 - 3	-	-																																																																																						
K 36/100 M	033230	1 x 220-240 V ~	2,1	1,85	2,5	8,8	40	450																																																																																						
K 36/100 T	033235	3 x 230-400 V ~	2	1,85	2,5	6,9 - 4	-	-																																																																																						
K 12/200 M	033240	1 x 220-240 V ~	1,05	0,75	1	4,6	20	450																																																																																						
K 12/200 T	033245	3 x 230-400 V ~	1,02	0,75	1	3,6 - 2,1	-	-																																																																																						

K 20/41

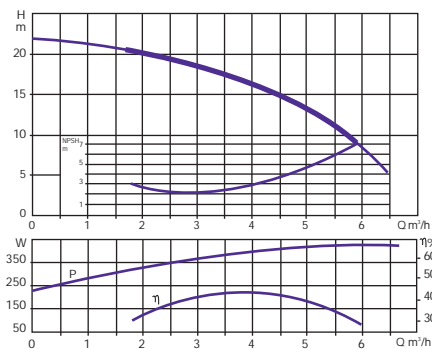

K 30/70

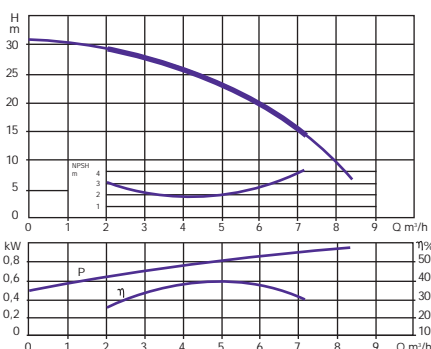

K 30/100

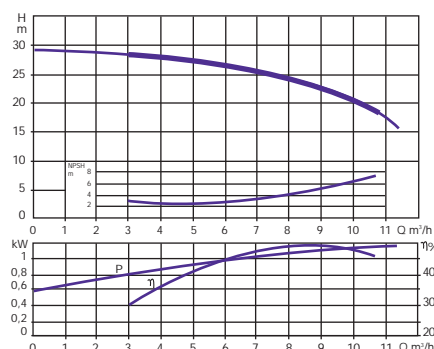

K 36/100

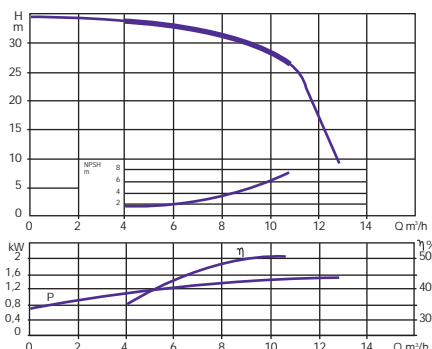

K 12/200

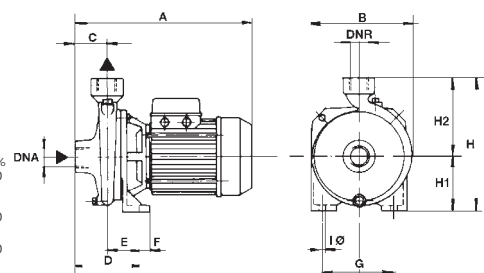
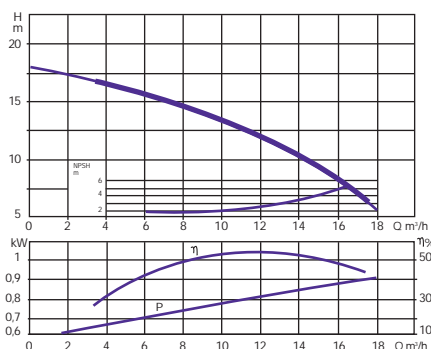

TYPE	A	B	C	D	E	F	G	I Ø trous	H	H1	H2	DNA	DNR	Dimensions emballage			Volume (m ³)	Poids kg
														L/A	L/B	H		
														K 20/41	300	160		
K 30/70	303	185	50	108	58	15	140	9	235	100	135	1" G	1" G	386	226	272	0,024	14,5
K 30/100	333	200	50	114	64	15	140	9	255	105	150	1" 1/2 G	1" G	427	246	307	0,032	18,5
K 36/100	333	200	50	114	64	15	140	9	255	105	150	1" 1/2 G	1" G	427	246	307	0,032	19,7
K 12/200	335	169	45	114	69	15	110	9	210	85	125	1" 1/2 G	1" 1/2 G	392	232	280	0,024	14

DISTRIBUÉ PAR